

Standards, Design & Installation of CATV-Cables

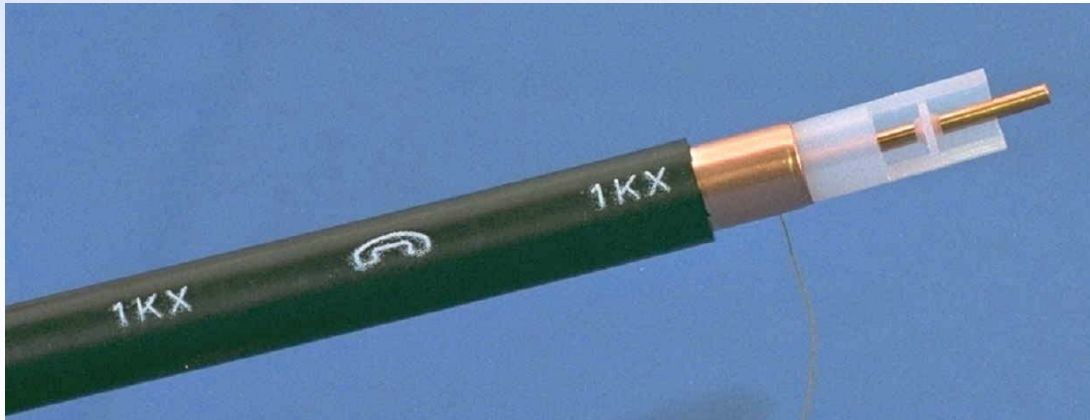
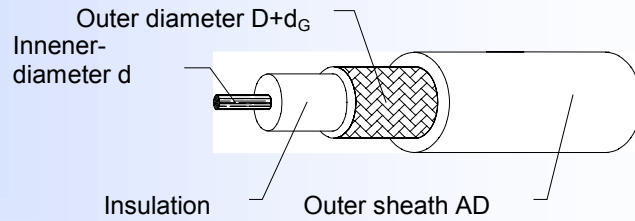

Bernhard Mund, [bedea](http://bedea.com) Berkenhoff&Drebes GmbH, Herbornerstrasse 100, D-35614 Asslar, Germany, bmund@bedea.com

1-1

Standards, Design & Installation of CATV-Cables

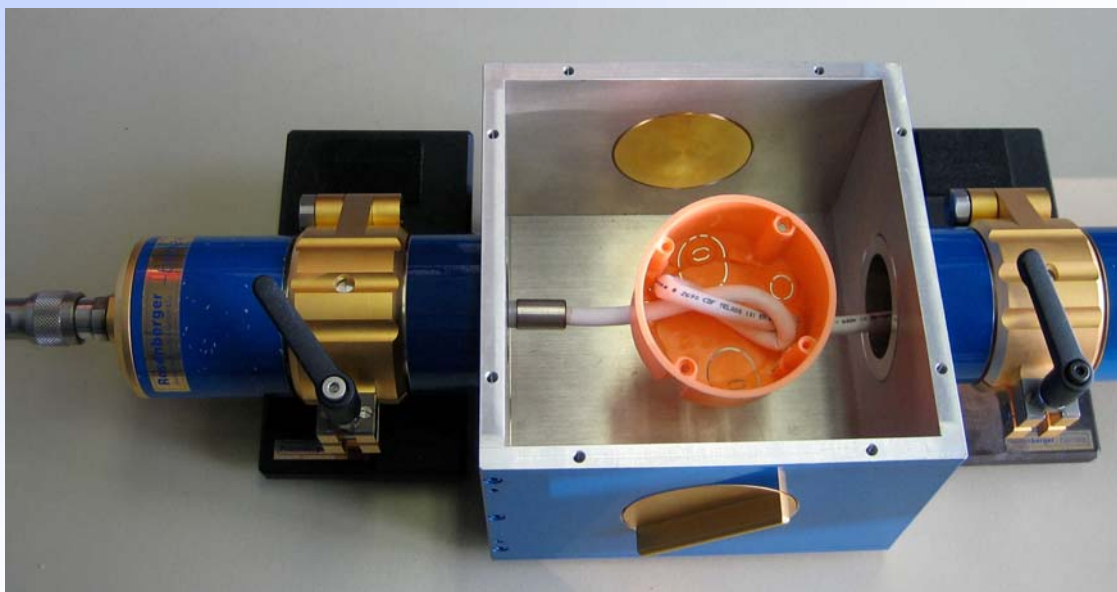

Measuring of screening attenuation on Telass CDF 101 in TV socket box

Bernhard Mund, [bedea](http://bedea.com) Berkenhoff&Drebes GmbH, Herbornerstrasse 100, D-35614 Asslar, Germany, bmund@bedea.com

1-2

Standards, Design & Installation of CATV-Cables



- Author: Bernhard Mund,
 - ◆ *Radio & TV Technician, Radio Brand, Marburg, 1970*
 - ◆ *Dipl.-Ing. Communication-& Microproc. technologies, FH Giessen 1984*
- **bedea** Berkenhoff&Drebes GmbH, Asslar since 1985
 - ◆ **bedea** Manufacturer of Communication Cables, Germany
- Responsible:
 - ◆ R&D Manager & RF- and EMC-measurements,
 - ◆ **Standardisation:**
 - ◆ Chairman of UK 412.3, Koaxialkabel, (German NC)
 - ◆ Secretary of CENELEC SC 46XA, Coaxial cables
 - ◆ Secretary of IEC SC 46A, Coaxial cables

Outline



- Characteristics of CATV-cables
 - ◆ Characteristic impedance,
 - ◆ Attenuation, Return loss
- Installation practices
 - ◆ Tensile strength and bending
 - ◆ Installation precautions
- EMC of CATV-Cables, Screening classes
- Standards
 - ◆ EN 50117-2-1 to -2-5, EN 50117-4-1, CATV-Kabel
 - ◆ EN 60966-2-4 bis -2-6, TV receiver leads
- Discussion



Basic characteristics of coaxial cables

The **characteristic impedance** Z of a RF-coaxial cable is given by the ratio of inner conductor diameter d to outer conductor diameter D (D/d) and the dielectric constant ϵ_r of the insulation material. For frequencies > 10 MHz Z in Ohm is:

$$Z = \frac{60}{\sqrt{\epsilon_r}} \cdot \ln\left(\frac{D}{d}\right)$$

Shunt **Capacitance** per unit length, in **pico farads** per meter is:

$$C' = \frac{55,6 \cdot \epsilon_r}{\ln(D/d)}$$

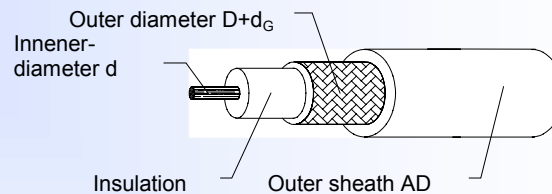

Series **Inductance** per unit length, in **Henrys per meter** is:

$$L' = \frac{\mu_0 \mu_r}{2\pi} \cdot \ln \frac{D}{d}$$

As Insulation material **Polyethylen (PE)** with a dielectric constant ϵ_r of 2,28 and **(physically) foamed Polyethylen (CELL-PE)** with ϵ_r in the range of 1,35 - 1,5 is mainly used for CATV cables. (CELL-PE = cellular Polyethylene, μ = magnetic permeability)

Test procedure to measure Characteristic impedance is given in: IEC 61196-1-108 and EN 50289-1-11

Reflection coefficient

A RF-signal which is travelling through a **transmission line** with the **nominal characteristic impedance** Z_n will be reflected on every point of this line where it meets irregularities with a deviation from the nominal characteristic impedance Z_n . The **reflection factor** at a point of irregularity is designated by the **reflection coefficient** r_e of a single reflection which is given by:

$$r_e = \frac{Z_L - Z_n}{Z_L + Z_n}$$

where

Z_n is the characteristic impedance of the cable

Z_L is the characteristic impedance at the point of irregularity.

The reflection **coefficient** r_e of a cable is "1" at an open end, "-1" at a shortened end and zero in the case of matching with the **nominal characteristic impedance**, (**75 Ω** at CATV-systems.)

At standard applications like **CATV-networks** random or stochastic distributed irregularities over the cable length will not affect signal transmission if the reflection coefficient r_e of a single reflection point is **< 0,01 respectively > 40 dB**.

Periodic disturbances

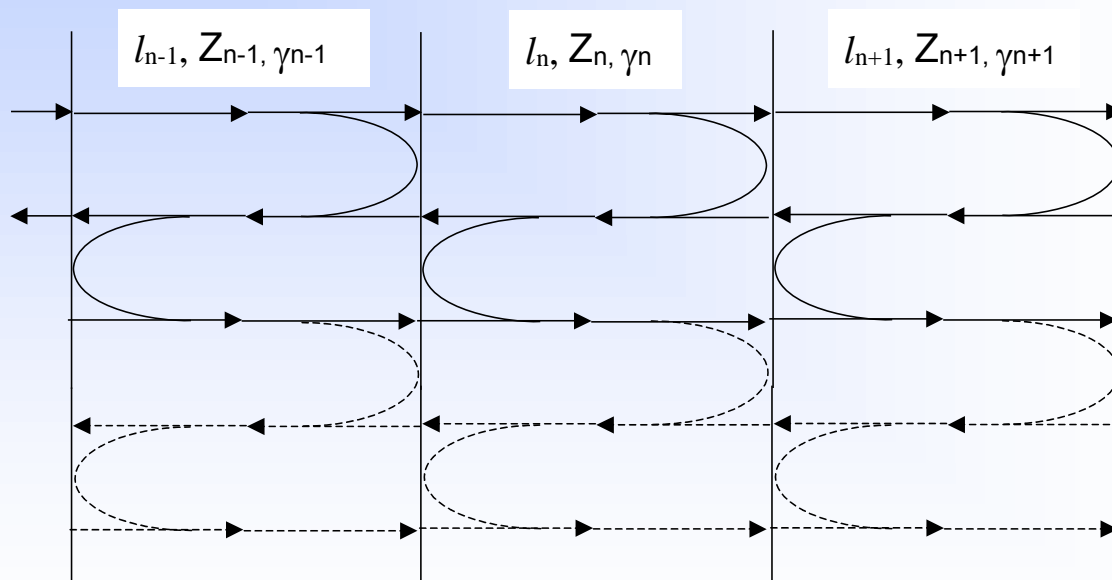

Input reflection factor

The total **input reflection factor** \underline{R} at the input of the cable is the sum of the single reflections r_e . If the irregularities of the cable are of a **periodic distance** l_0 , the reflected signal and with that the total input **reflection factor** \underline{R} at the input end of the cable will be a maximum at the **resonance frequency** f_r which is obtained to:

$$f_r = \frac{c_0 \cdot v_K}{2 \cdot l_0}, \quad = \frac{c_0}{2 \cdot l_0 \cdot \sqrt{\epsilon_r}}$$

where

c_0 is the propagation velocity in free space

v_K is the velocity ratio

ϵ_r is the **relative dielectric permittivity** of the insulation material

Note, that the **wave length** λ of the **resonance frequency** f_r is $2 l_0$.

Return loss

The **return loss** a_r is a measure of the deviation from the **mean characteristic impedance** of a cable in the frequency domain and is the most important quality characteristic of a RF-coaxial cable. The **return loss** a_r is defined as:

$$a_r = 20 \cdot \log(u_i / u_r), \quad = 20 \cdot \log(1 / \underline{R}) \quad \text{in dB}$$

where

u_i is the magnitude of the incident wave with reference to the impedance Z_n

u_r is the magnitude of the reflected wave with the cable terminated with Z_n

Z_n is the nominal characteristic impedance of the cable.

\underline{R} is the **input reflection factor**

The **return loss** a_r is related to the total **input reflection factor** \underline{R} by:

$$\underline{R} = (u_r / u_i) = 10^{-(a_r/20)}$$

It is indirectly related to the **standing wave ratio** s by: $s = \frac{(1+R)}{(1-R)}$

Reflection peaks

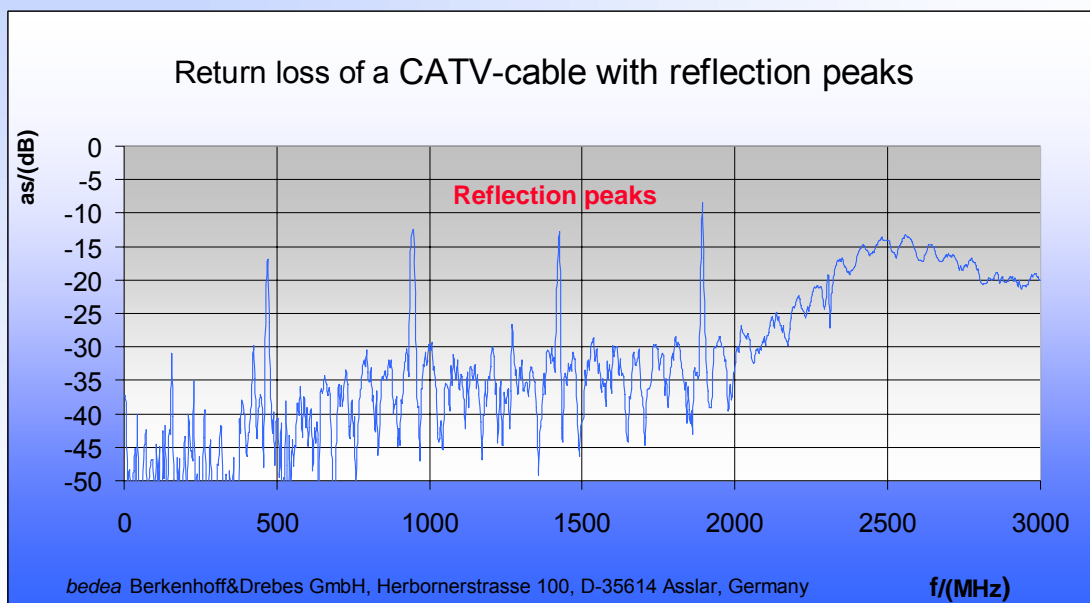

The limit values of the return loss are stated in EN 50117-2-1 to-2-5 and in EN 50117-4-1

Measuring of Return loss

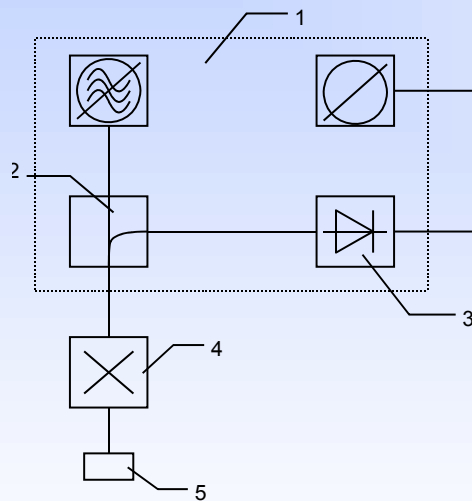

- 1 network analyser
- 2 directional coupler or bridge
- 3 demodulator
- 4 DUT (device under test)
- 5 load

Number of points shall be
≥ **20.000** per measuring !

$$r = \frac{Z_0 - Z_L}{Z_0 + Z_L} \quad a_r = 20 \cdot \log(1/r) \quad (\text{dB})$$

The **return loss** is the measure for the **equability** of the characteristic impedance and therefore the essential **Quality Criteria** of a coaxial cable !

The test procedure to measure **Return loss** is given in: IEC 61196-1-112 and EN 50289-1-11

Bernhard Mund, *bedea* Berkenhoff&Drebes GmbH, Herbornerstrasse 100, D-35614 Asslar, Germany, bmund@bedea.com

1-11

Return loss limits

EN 50117-2-3

RL = 26 dB min. from 5 MHz to 30 MHz
 RL = 26 dB min. from 30 MHz to 470 MHz
 RL = 23 dB min. from 470 MHz to 1 000 MHz

EN 50117-2-1/-2-2/-2-4/-2-5 & EN 50117-4-1

Für Kabel mit $\alpha \leq 18$ dB/100 m bei 800 MHz

RL = 23 dB min. from 5 MHz to 30 MHz
 RL = 23 dB min. from 30 MHz to 470 MHz
 RL = 20 dB min. from 470 MHz to 1 000 MHz
 RL = 18 dB min. from 1 000 MHz to 2 000 MHz
 RL = 16 dB min. from 2 000 MHz to 3 000 MHz

(α is the attenuation of the cable)

Measurement accuracy:

In case of digital signal processing, the **accuracy** of the **return loss measurement**, $\Delta_{ar,f}$ depends on the frequency step Δ_f in the measured frequency range. The frequency spacing in the measured frequency range is frequency dependent and shall be in accordance with the following equation:

$$\Delta_f \leq 1.4 \cdot \frac{300 \cdot v_r}{868.6 \cdot \pi} \cdot a(f) \cdot \sqrt{10^{\frac{\Delta_{ar,f}}{10}} - 1}$$

bedea is measuring with > 20.000 points

where $a(f)$ is the attenuation of the cable at the measured frequency point in dB/100m, $\Delta_{ar,1}$ is the max. uncertainty of measurement due to frequency spacing; and v_r is the nominal velocity. The **measurement inaccuracy** $\Delta_{ar,f}$ shall be ≤ 1 dB unless otherwise stated in the relevant detail spec.

Bernhard Mund, *bedea* Berkenhoff&Drebes GmbH, Herbornerstrasse 100, D-35614 Asslar, Germany, bmund@bedea.com

1-12

Attenuation

On its way through the cable the signal strength will degrade due to **losses** in the **conductors** and **losses** the **dielectric**.

This **Attenuation** is caused by the "**Skin effect**" (current density near the surface of the conductor is greater than that at its core, which increases with increasing frequency) and by increasing loss in the dielectric, which increases also with frequency.

in order to add the attenuation of different cable length as well as of different devices, **Attenuation** is given in **Decibels/m** (dB/m), (resp. per unit), usually in **dB/100 m**

Attenuation is given in the **data sheets** of the manufacturer at certain frequencies

Attenuation at f_2 at known f_1 (approach): $\alpha_1/\alpha_2 = \sqrt{(f_1/f_2)}$, (α /dB, f/MHz)

Attenuation may also be given by **Attenuation constants**: $\alpha(f) = a*f + b*\sqrt{f} + c$

The test procedure to measure Attenuation is given in: IEC 61196-1-113 and EN 50289-1-8

Attenuation curve

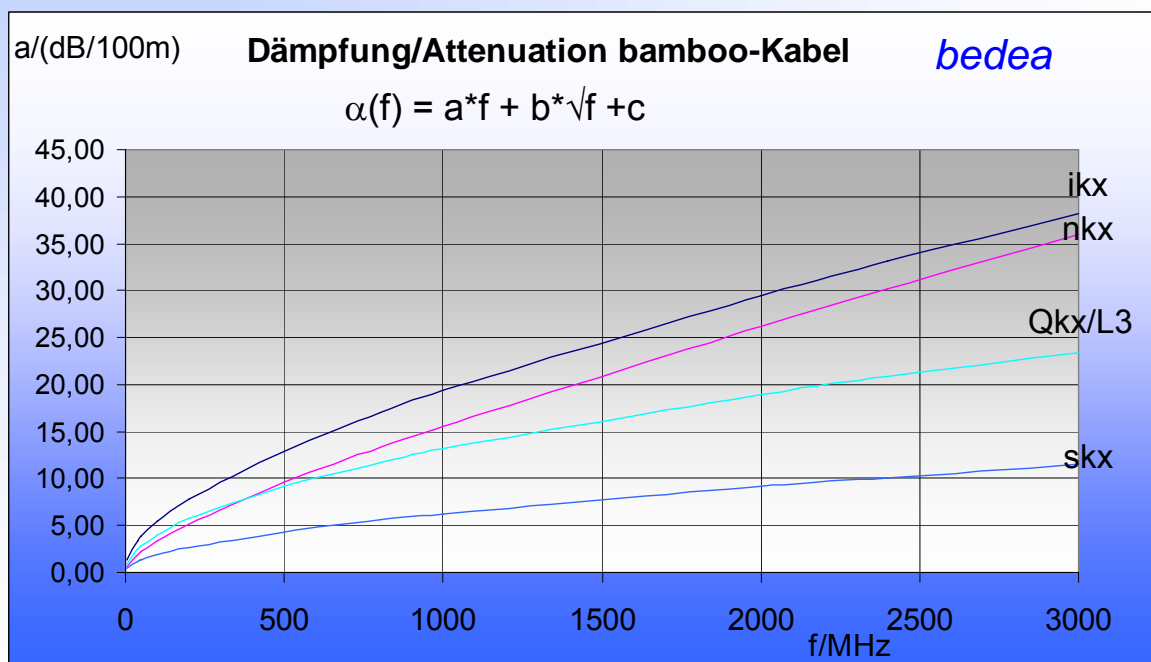

DIN 18015-1 Abschnitt 7.4, Rohr und Verteilnetz



- Kabel und Leitungen müssen auswechselbar und gegen Beschädigung geschützt verlegt werden,
- sie dürfen ([unter Beachtung von DIN EN 50174-2 Abs. 6.5](#)) in Schächten zusammen mit Starkstromkabeln bis 1000 V verlegt werden. **EMV und Sicherheit !**
- Eine Verlegung direkt in Putz ist nicht zulässig.
- Die Auswahl von Kabeln und Leitungen ist in Bezug auf äußere Einflüsse (z. B. mechanisch, thermisch, chemisch) zu treffen. Die Umgebungstemperatur der Leitung darf im Regelfall + 55 °C nicht überschreiten, dies ist insbesondere bei der Verlegung in **Heizungskanälen** oder -schächten und Dachräumen zu beachten.
- ... sind mindestens 2 **Leerrohre** zwischen oberstem Geschoss (Dachgeschoss) und unterstem Geschoss (Kellergeschoss) mit einem Innendurchmesser von je mindestens 30 mm vorzusehen, für die Wohnungszuführung solche mit mindestens 23 mm.
- Für die Montage von Antennensteckdosen sind **60 mm** tiefe Unterputz-Geräteabzweigdosen zu verwenden.

Operating datas of coaxial cables (IEC 60096-0-1)



Minimum bending radius of Coaxial cables	5 × outer diameter for single indoor laying 10 × outer diameter for single outdoor laying (respectively bending under tensile strength or multiple bending)
Minimum permissible laying temperature	−15 °C dielectric PE, sheath PVC quality 1 −40 °C dielectric PE, sheath PVC quality 2 −55 °C dielectric and sheath FEP and PTFE Cautious laying without shocks recommended
maximum Tensile strength	approx. 50 N pro mm ² Copper (Inner- & Outer conductor), see data sheet of the manufacturer

Detailed operating information of cables shall be given in the relevant cable specification of the manufacturer ([e.g. www.bede.com](http://www.bede.com))

Bending of cables in TV socket

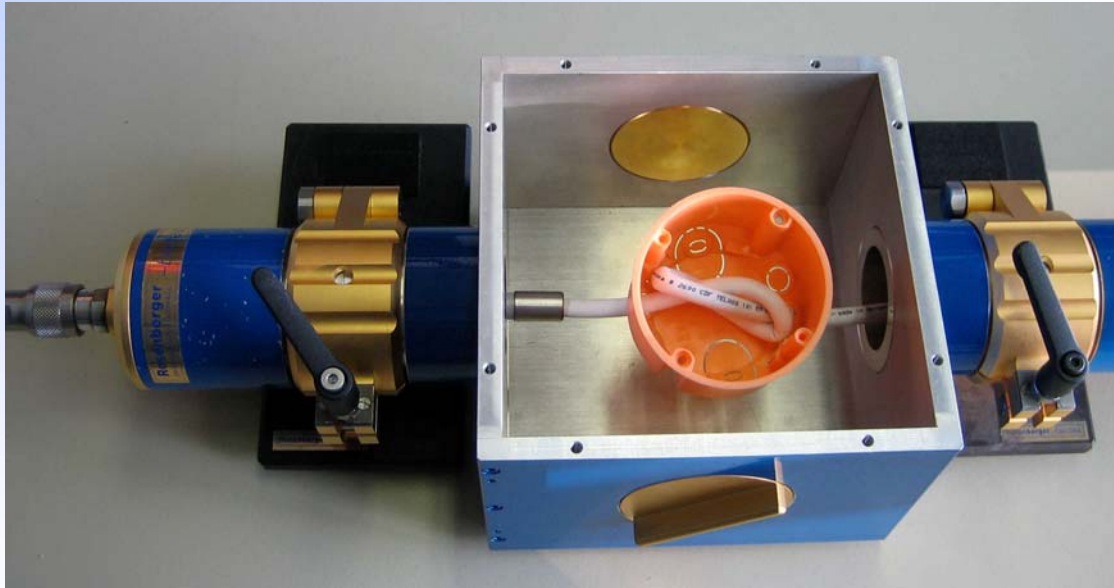

Measuring of screening attenuation Telass CDF 101 in TV socket

Minimum bending radius of Coaxial cables in TV socket falls below IEC 60096-0-1

Bernhard Mund, [bedea](http://www.bedeade.com) Berkenhoff&Drebes GmbH, Herbornerstrasse 100, D-35614 Asslar, Germany, bmund@bedeade.com

Bending radius in TV socket box

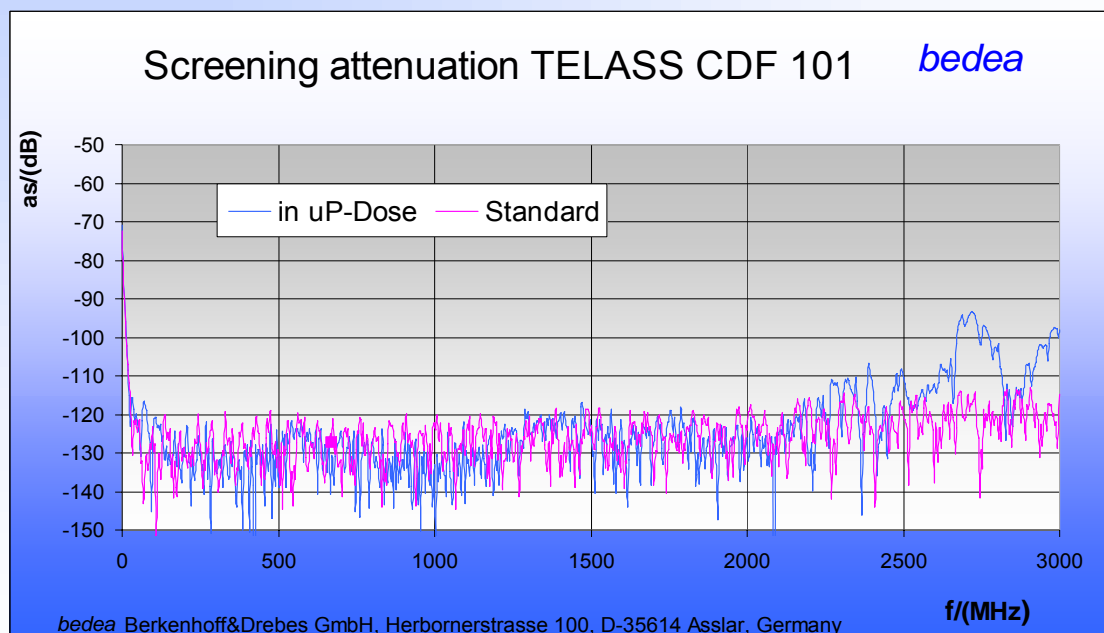

from 30 MHz to 3 GHz, requirements of Screening class A+ are met also after extreme bending

Bernhard Mund, [bedea](http://www.bedeade.com) Berkenhoff&Drebes GmbH, Herbornerstrasse 100, D-35614 Asslar, Germany, bmund@bedeade.com

Installation instructions of CATV-cables



- **Quality requirements:**
 - ◆ Use only cables with gas injected insulation (**physically foamed**)
 - ◆ with **screening class A** or better
- **Use of clamps:**
 - ◆ avoid **cable clamps** (where possible) and use instead conduits or ducts
 - ◆ dont fix **clamping straps** too tight.
 - ◆ (pressure to the dielectric will lead to deviation of the Characteristic Impedance)
- **Installation close to heat sources:**
 - ◆ dont install coaxial cables close to **heat sources** (heating intallations)
 - ◆ foamed dielectric **starts to melt** at about ca. 65 °C
- **The use of cable conduits and ducts is strongly recommended**

Cable connections & EMC



- Cable connections are **EMC-error source No 1:**
- **preparing of all cables with appropriate tools**
 - ◆ fitting **tools** for all cables are available
 - ◆ note the **assembly instructions** of the manufacturer
 - ◆ also for buried boxes
- **mounting of coaxial connectors to the coaxial cables**
 - ◆ use only connectors which are designed for the relevant cable
 - ◆ in case of doubt ask the cable and/or the connector manufacturer
 - ◆ note the **assembly instructions** of the manufacturer
- **good screening attenuation will be achieved with F-Compression Connectors**
- **Through connection of coaxial cables**
 - ◆ coaxial cable connections shall be **coaxial** only !

Radiation limits (SchuTSEV) Ge



The “BundesNetzAgentur - BNetzA (ehem. (RegTP))”, has established the “Sicherheitsfunk-Schutzverordnung - SchuTSEV” (former NB 30) which gives Radiation limits for Telecommunication installations.

Frequency, f, in the range	Radiation limits (peak value in 3 m distance, dB(μV/m))	measuring bandwidth
0,009 to 0,15 MHz	$40 - 20 \log_{10} f(\text{MHz})$	200 Hz
> 0,15 to 1 MHz	$40 - 20 \log_{10} f(\text{MHz})$	9 kHz
> 1 to 30 MHz	$40 - 8,8 \log_{10} f(\text{MHz})$	9 kHz
> 30 to 108 MHz	$27^{1)}$	120 kHz
> 108 to 144 MHz	$18^{2)} 27^{1)}$	120 kHz
> 144 to 230 MHz	$27^{1)}$	120 kHz
> 230 to 400 MHz	$18^{2)} 27^{1)}$	120 kHz
> 400 to 1000 MHz	$27^{1)}$	120 kHz
> 1 to 3 GHz	$40^{2)}$	1 MHz

1) Dies entspricht der äquivalenten Strahlungsleistung von 20 dBpW

2) Der Wert von 18 dB(μV/m) gilt nur für breitbandige, digitale leitergebundene (Rundfunk-)Signale. Für alle anderen Signale beträgt dieser Wert 27 dB(μV/m).

3) Dies entspricht der äquivalenten Strahlungsleistung von 33 dBpW

Measuring of radiation, RegTP, airfield Asslar



To establish radiation limits of CATV-cables measurements have been achieved by RegTP in co-operation with bedea at the airfield in Asslar.

height: 5 meter,
length 33 meter

RegTP = German authority for Telecommunication & postal service (= BNetzA)

Measuring of radiation, RegTP, airfield Asslar

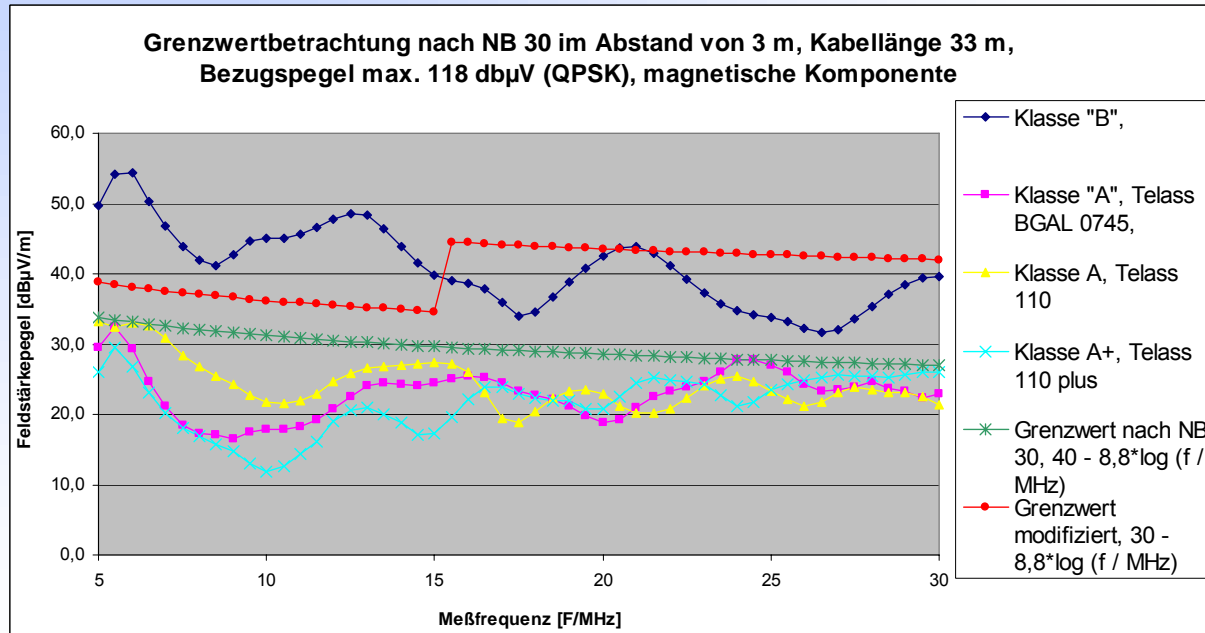

Measuring of radiation, RegTP, airfield Asslar

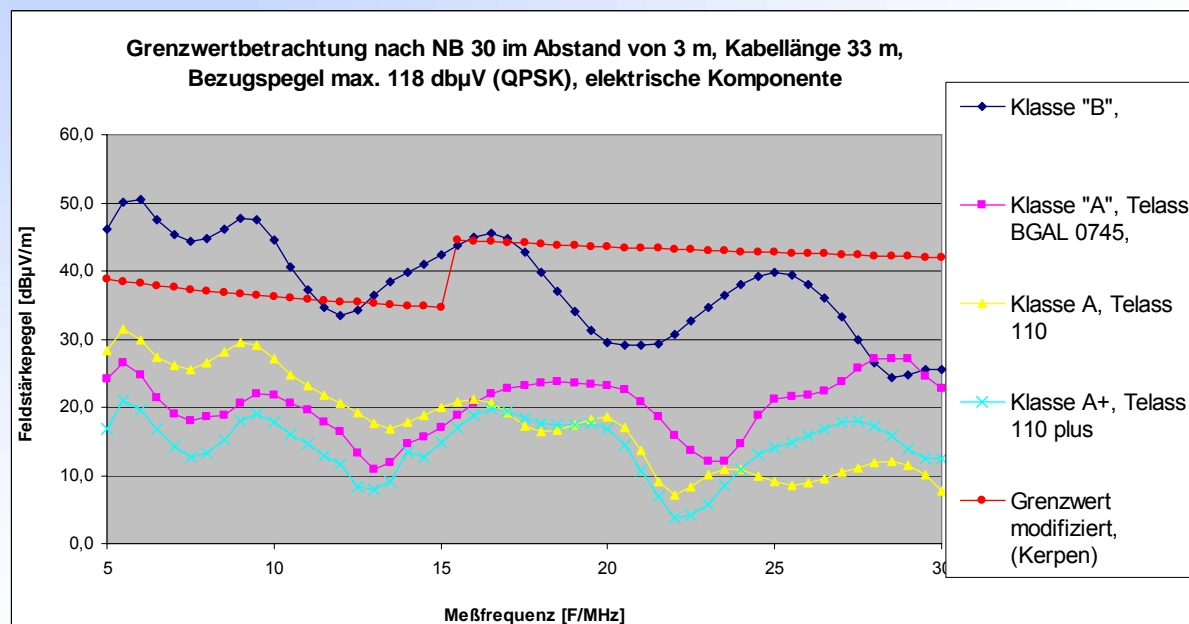

Screening Classes acc. to EN 50117



Screening Class	5 - 30 MHz	30 -1000 MHz	1 GHz – 2 GHz	2 GHz – 3 GHz
C	50 mOhm/m	75 dB	65 dB	55 dB
B	15 mOhm/m	75 dB	65 dB	55 dB
A	5 mOhm/m	85 dB	75 dB	65 dB
A+	2,5 mOhm/m	95 dB	85 dB	75 dB
A++	0.9 mOhm/m	105 dB	95 dB	85 dB

Classe A & B are valid for cables acc. to EN 50117-2-1/-2-2/-2-4 und /-2-5
Screening Class A++ is valid for CATV-cables acc. to EN 50117-2-3

Transfer impedance and Screening attenuation shall be measured with the
"Triaxial test procedure" according to EN 50289-1-6 (CoMeT)

Absorbing clamps are not allowed, due to large uncertainty and poor reproducibility

Measuring with the test set-up CoMeT



Transfer impedance & Screening attenuation
few kHz up to and above 8 GHz with one test set-up

Test set-up CoMeT
designed by bedea
and distributed worldwide

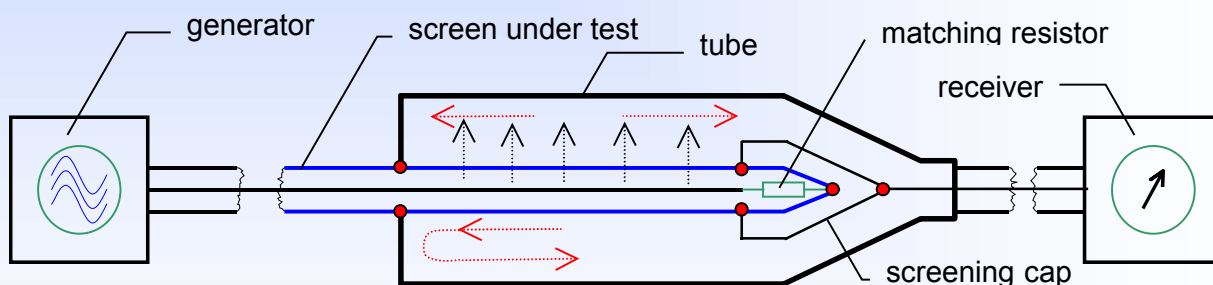

IEC 62153-4-3 Transfer impedance, IEC 62153-4-4 Screening attenuation
EN 50289-1-6 EMC on Communication cables

Calculated Coupling Transfer Function T_{nf}

Calculated Coupling Transfer Function T_{nf}

$$T_{s,n} = (Z_F \pm Z_T) \cdot \frac{1}{\sqrt{Z_1 \cdot Z_2}} \cdot \frac{l}{2} \cdot S_n$$

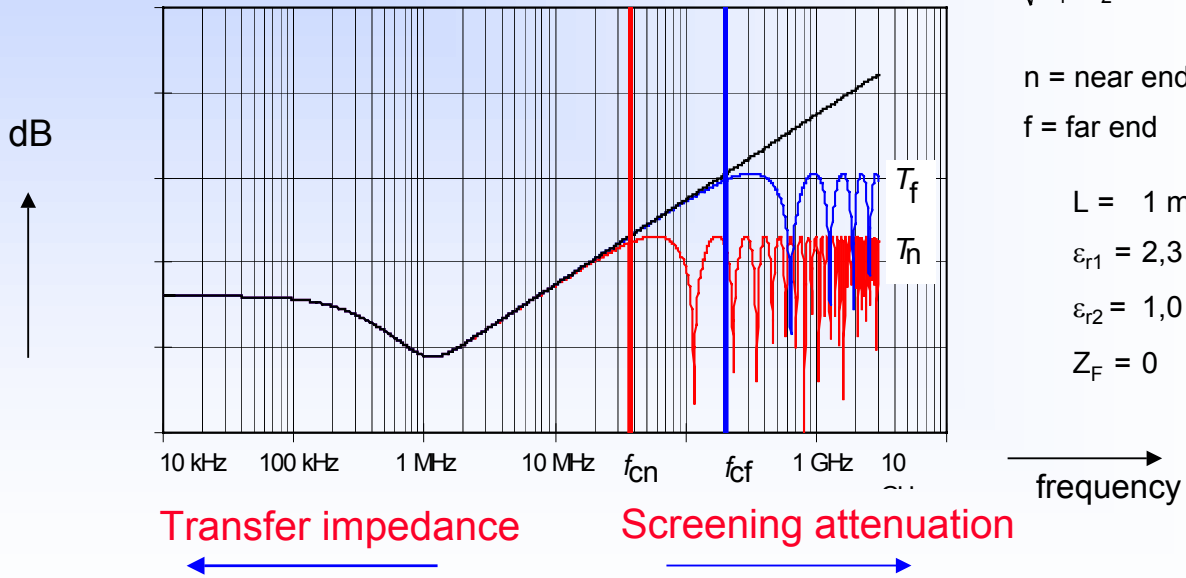

Measured Transfer function of RG 058

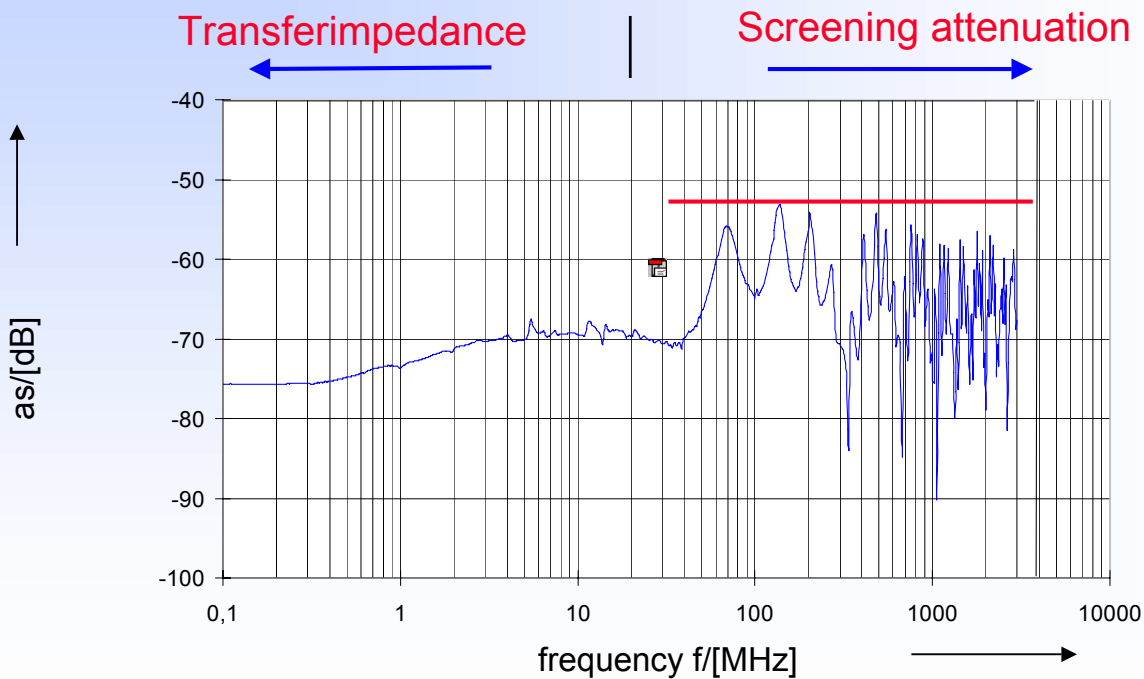

Cable with small hole, tube in tube, 0,5 m



Well screened CATV-Cable with F-Connector

Same cable with one small hole, 3 mm

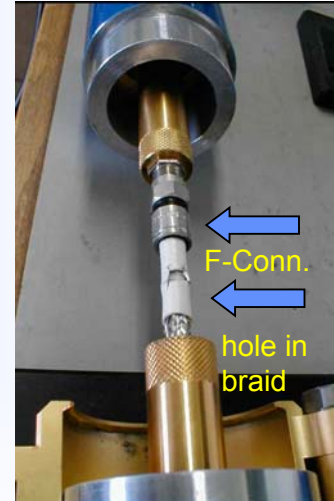
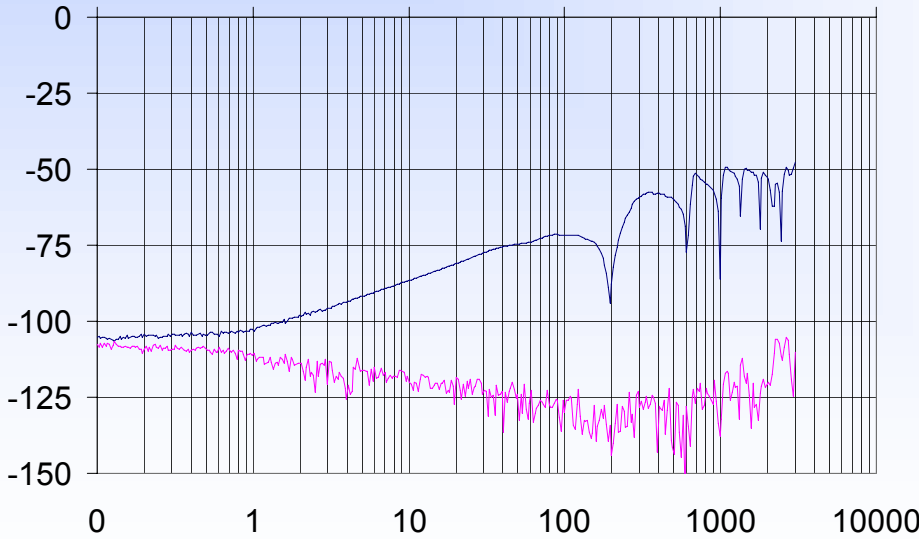

EMC-measurements in Return path (KDG)

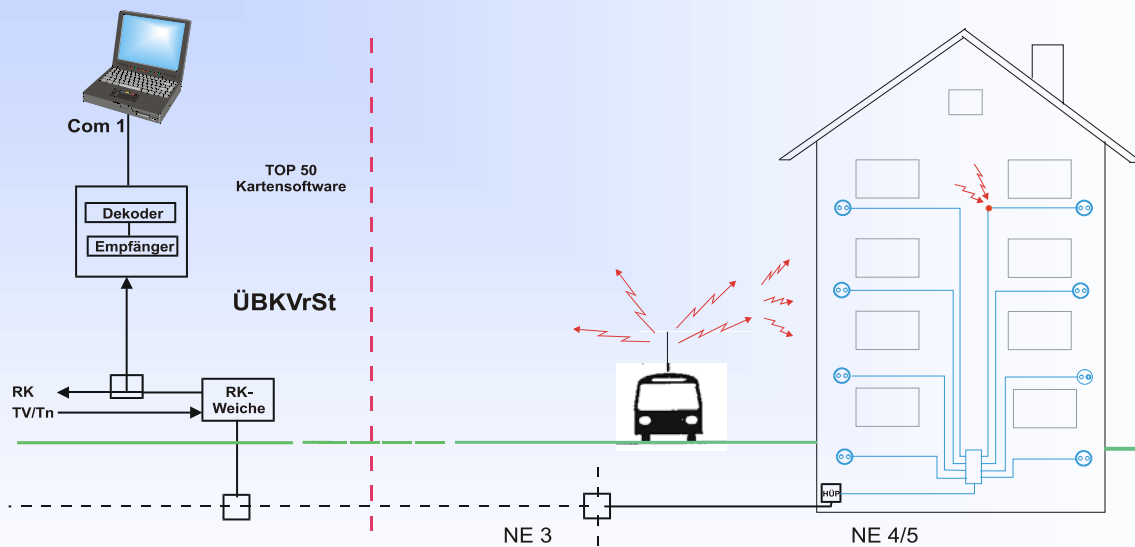

Car contains radio transmitter mit GPS-receiver, disturbing-signal is coupled into the CATV installation at a weak point and transmitted with GPS info to the head end (respective to CO) via return path

Mit freundlicher Genehmigung, H. Hünninghausen, KDG

TV receiver leads

- The main source of error in CATV systems are TV receiver leads with insufficient screening attenuation (**DECT problems**).
- Screening of TV receiver leads shall be in accordance with screening class A (EN 50117)
- appropriate TV receiver leads are standardised in **EN 60966-2-x**

	Detail specification for cable assemblies for radio and TV receivers -	
EN 60966-2-4 Ed3	0 to 3000 MHz, IEC 61169-2 connectors	2009-01
EN 60966-2-5 Ed3	0 to 1000 MHz, IEC 61169-2 connectors	2009-01
EN 60966-2-6 Ed3	0 to 3000 MHz, IEC 61169-24 connectors	2009-01

Standards for CATV-cables, EN 50117

EN 50117-1, Ed.2	Coaxial cables - Generic specification	2007-07
	Sectional specifications for cables used in cabled distribution networks (CATV)	
EN 50117-2-1 Ed2 (replaces EN 50117-2)	Indoor drop cables for systems operating at 5 MHz - 1 000 MHz	2008-08
EN 50117-2-2 Ed1 (replaces EN 50117-3)	Outdoor drop cables for systems operating at 5 MHz - 1000 MHz	2008-08
EN 50117-2-3 Ed1 (replaces EN 50117-4)	Distribution and trunk cables, operating at 5 MHz - 1000 MHz	2008-08
EN 50117-2-4 Ed1 (replaces EN 50117-5)	Indoor drop cables for systems operating at 5 MHz - 3000 MHz	2008-08
EN 50117-2-5 Ed1 (replaces EN 50117-6)	Outdoor drop cables for systems operating at 5 MHz - 3000 MHz	2008-08
EN 50117-4-1 Ed1	Sectional specification for cables for BCT cabling in accordance with EN 50173 - Indoor drop cables for systems operating at 5 MHz - 3 000 MHz	2009-02

Common Path Distortions (CPD)

The **Return Path** has been a source of new income by majority of Cable operators. due to different applications like high Speed data, Telephony and other services.

Return Path has proven to be prone to **Ingress, Noise** and the dreaded **Common Path Distortions (CPD)** respectively **Passive Intermodulation (PIM)**

CPD is the generation of **unwanted frequencies** ($f_1 \pm f_2$) beside the **useful frequencies f_1** on connections between the cable and connectors or devices

due to **Diode or Bimetallic effects**

and also **ageing effects** due to **corrosion** (among other effects).

IEC Technical Committee **TC 46 WG6** has determined the specs for measuring PIM in mobile networks (50 Ohms at 900 MHz and 1800 MHz)
another testprocedure for CPC is described in **ANSI/SCTE 109 2005**

Hints to avoid PIM on coaxial cables

avoid magnetic materials like **Copper clad steel** (Staku) as conductors

Copper **Braid wires** on **Aluminium Foils** shall be **tinned** (Galvanic Cell)

Aluminium in moist surrounding will lead to corrosion --> CPD

For buried cables and cables laid in moist surrounding, Cables with pure copper foil/band **have been proven for over 25 years** in Germany

The use of **high quality** cables and connectors is strongly recommended, also with respect to ageing effects

The **CPD** problem is under consideration at **DKE(VDE)** and **CENELEC**

Conclusion 1

- The **characteristic impedance** Z of a RF-coaxial cable is given by the ratio of inner conductor diameter d to outer conductor diameter D (D/d) and the dielectric constant ϵ_r
- Die **return loss** is a measure for the **continuity** of the characteristic impedance and therewith **the main Quality characteristic** of a coaxial cable.
- (Failure in manufacturing may lead to **reflection peaks**)
- Attenuation of **Coaxial cables** is given in logarithmic ratio in **Decibel (dB)** per length, e.g. in **dB/100m**,
- When installing coaxial cables, specification of the manufacturer regarding minimum bending radius, maximum tensile strength temperature range..... shall be noted
- Use only gas injected (**physically foamed**) Coaxial cables or cables with solid PE
- Dont use **cable clamps** to fix the cable (especially not periodically)
- in order to avoid **CPD** (Common Path Distortion) resp. **PIM** the use of **high quality Cables and Connectors** is strongly recommended.

Conclusion 2

- Coaxial cables shall not be installed close to **heat sources**
- Connections of cables are **EMC error source No. 1**
- Good screening will be achieved with **F-Compression connectors**
- **Radiation limits** of Telecommunication systems are established at **SchuTSEV**
- by **BNetzA** (Germany),
- Radiation limits at CENELEC are still under consideration
- The use of **high Quality** cables and connectors with **Screening class A** or better (acc. to **EN 50117**) is strongly recommended
- Appropriate TV receiver leads are standardised in **EN 50966-2-x**
- **Standards for CATV-cables** are **EN 50117-2-1 to -2-5** and **EN 50117-4-1**
- Instructions of the manufacturer regarding tensile strength, bending, heat ... shall be noted
- **bedea** CATV cables of the TELASS[®] series **guaranties** proper operation

CoMeT Coupling Measuring Tube



Thanks for your attention



???

www.bedeas.com

bmund@bedeas.com

Standards, Design & Installation of CATV-Cables, Hemmink mini ZIGGO Congress 2009

bedea

bedea, Asslar (Wetzlar), Germany



325 Employees
approx. 30 Mio EUR turnover

Germany, 1889

Communication cables/Technical Yarns/Mini ropes/Data technology/Fiber light

Bernhard Mund, [bedea](http://bedeas.com) Berkenhoff&Drebes GmbH, Herbornerstrasse 100, D-35614 Asslar, Germany, bmund@bedeas.com